

1

2

3

4

5

6

A

A

B

B

C

C

D

D

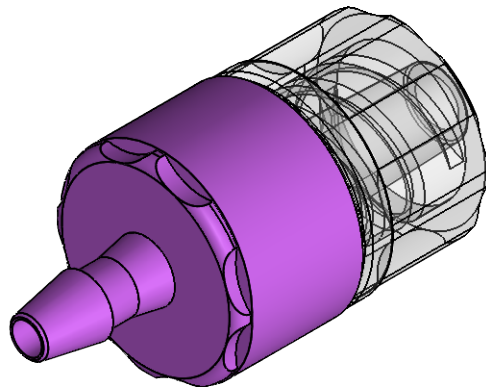
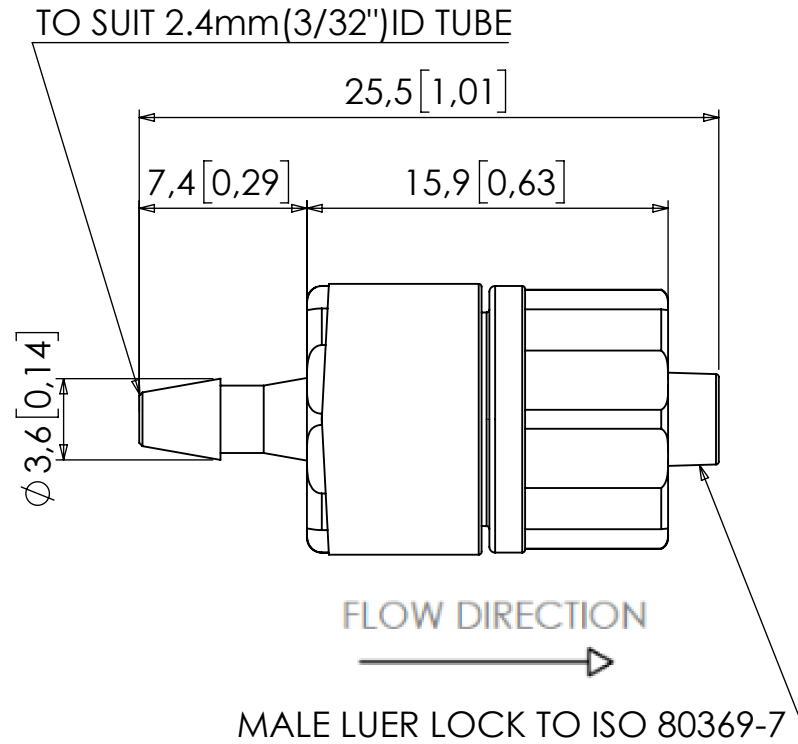
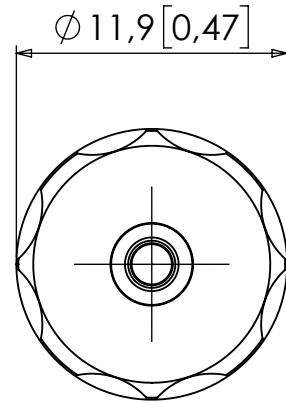

3	-	-		18/03/2026	FIRST RELEASE
REV	CREATED	CHECKED	APPROVED	REV DATE	REVISION SUMMARY

MATERIAL: ABS, POLYSTYRENE, SILICONE

THIS DRAWING IS CONFIDENTIAL AND IS THE PROPERTY OF THE WEST GROUP LTD AND MAY NOT BE REPRODUCED IN WHOLE OR IN PART, OR USED FOR ANY OTHER PURPOSE OTHER THAN THAT FOR WHICH IT IS SUPPLIED. ALL RIGHTS IN RESPECT OF PATENTS, DESIGN AND COPYRIGHTS RESERVED.



WEST GROUP LTD, UK
 TEL: +44 (0) 23 9226 6031
 WWW.WESTGROUP.CO.UK
 SALES@WESTGROUP.CO.UK

TITLE: ISO 80369-7 CHECK VALVE, MALE LUER LOCK TO 3/32" BARB, POLYSTYRENE/ABS BODY WITH SILICONE DISC

	DIM'S mm[inch]	SCALE NTS	SIZE A4	SHEET 1 / 1	DOCUMENT NUMBER E-C-3BML-ABS-S01	REVISION 3
--	-------------------	--------------	------------	----------------	-------------------------------------	---------------

1

2

3

4

5

6