

1

2

3

4

5

6

A

A

B

B

C

C

D

D

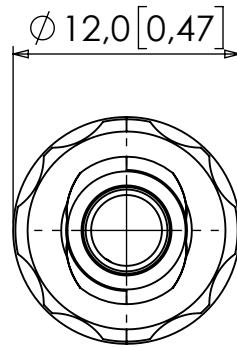

FEMALE LUER
LOCK TO ISO
80369-7

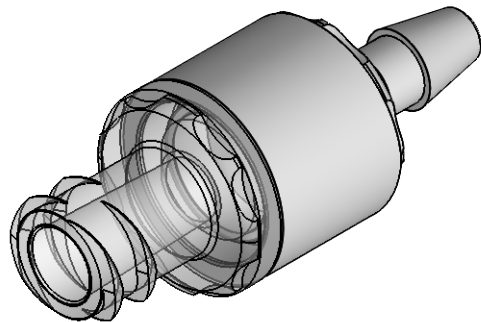
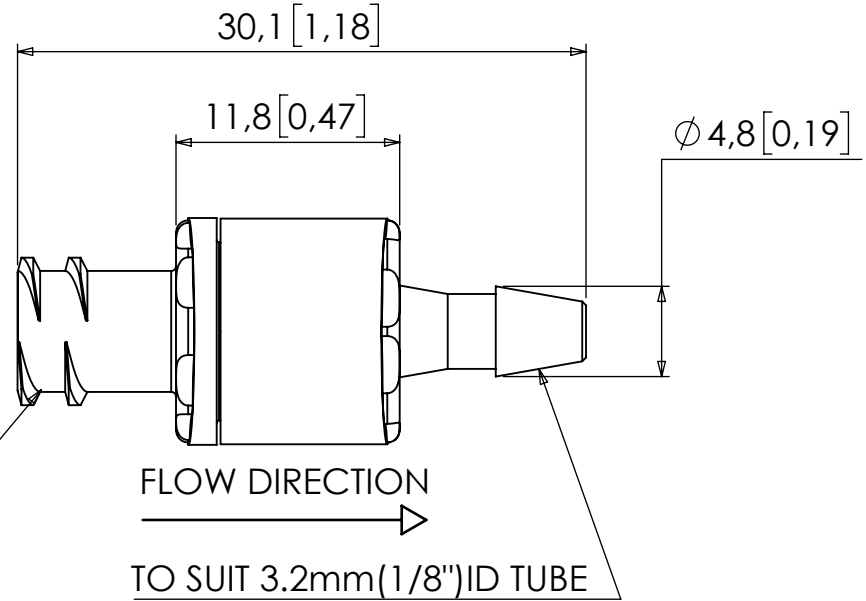

3				18/03/2026	FIRST RELEASE
REV	CREATED	CHECKED	APPROVED	DWG DATE	REVISION SUMMARY

MATERIAL: ABS, POLYSTYRENE, GLASS FIBRE, HDPE

THIS DRAWING IS CONFIDENTIAL AND IS THE PROPERTY OF THE WEST GROUP LTD AND MAY NOT BE REPRODUCED IN WHOLE OR IN PART, OR USED FOR ANY OTHER PURPOSE OTHER THAN THAT FOR WHICH IT IS SUPPLIED. ALL RIGHTS IN RESPECT OF PATENTS, DESIGN AND COPYRIGHTS RESERVED.



WEST GROUP LTD, UK
TEL: +44 (0) 23 9226 6031
WWW.WESTGROUP.CO.UK
SALES@WESTGROUP.CO.UK

TITLE: ISO 80369-7 FILTERED CHECK VALVE, FEMALE LUER LOCK TO 1/8" BARB, POLYSTYRENE/ABS BODY WITH GLASS FIBRE FILTER

	DIM'S mm[inch]	SCALE NTS	SIZE A4	SHEET 1 / 1	DOCUMENT NUMBER E-M-FL4B-ABS-GF02	REVISION 3
--	-------------------	--------------	------------	----------------	--------------------------------------	---------------

1

2

3

4

5

6